

30" Integrated Wall Panel (REF 77790-3, 4, 5)

Manual part no. 725898, 80021929 Ver. B Revised 2017-04
© 2017 Welch Allyn

WARNING Welch Allyn is not responsible for the integrity of any mounting installation. Welch Allyn recommends that customers contact their Biomedical Engineering Department or maintenance service to ensure professional installation for safety and reliability of any mounting accessory.

1. Choose a location for the panel near the examination table and an electrical outlet.

Sample room layout

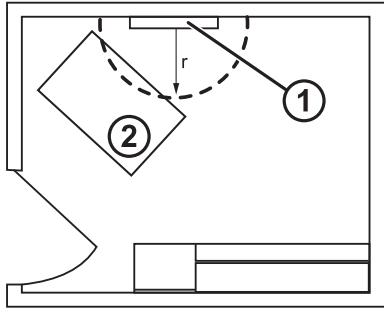

1. Panel
2. Examination table

2. On the selected wall, find and mark the studs, and choose the panel height and corresponding height for the mounting rail bracket.

Recommendation: Place the bracket 63 in. (160 cm) from the floor.

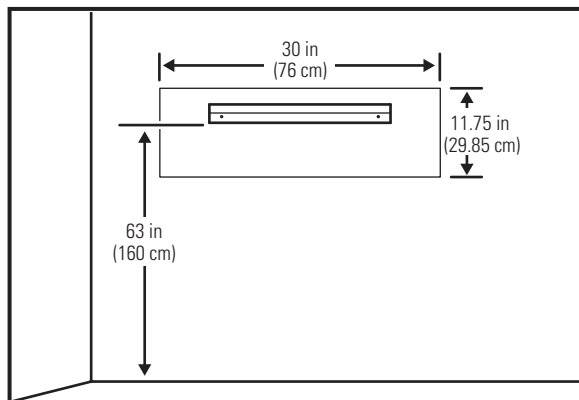

3. Affix the mounting rail bracket to two studs at the selected height using the available screws.

Caution Ensure that the upper "lip" of the bracket sticks out from the wall and that the bracket is level.

4. Hang the panel on the mounting rail bracket.

WARNING Ensure that the channel on the back of the panel fully engages the mounting rail bracket. The panel should be level and flush to the wall.

5. Secure the unit to the wall using the "A" screw.

WARNING Failure to install this security screw may result in personal injury and equipment damage.

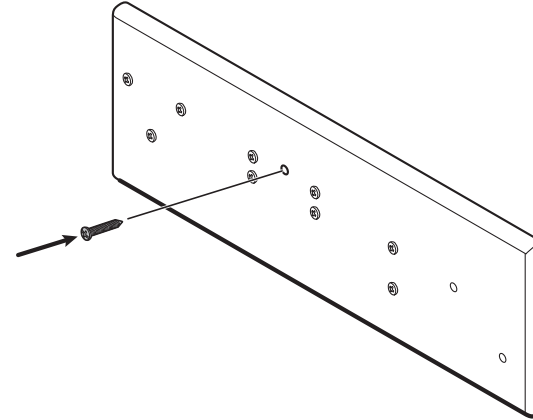

6. Mount the Welch Allyn products to the panel according to the figures on the reverse side of this instruction sheet.

Aneroid blood pressure gauge: position the gauge bottom on the pre-installed screw and then secure the top of the gauge using the two additional screws provided.

SureTemp® Plus thermometer: position the thermometer on the pre-installed screws and then secure it with the two additional screws provided.

Install the remaining products on the pre-installed screws.

For diagnostic systems without SureTemp thermometry, cover the unused screw holes with the FastCaps provided.

Instrument location—Aneroid blood pressure gauge

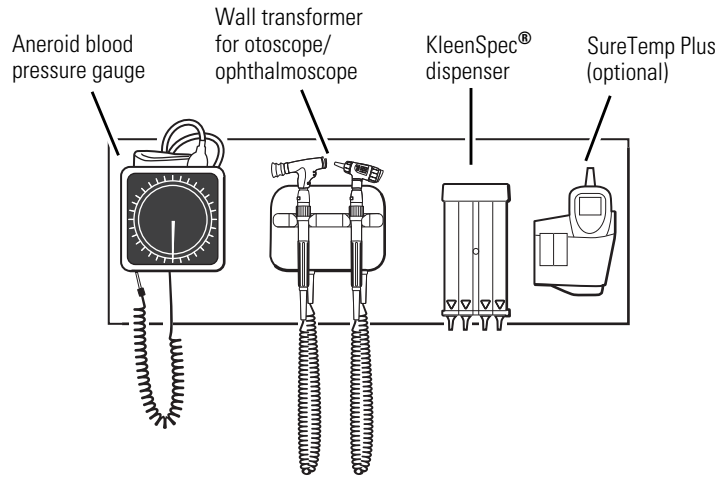

Instrument location—Spot Vital Signs®

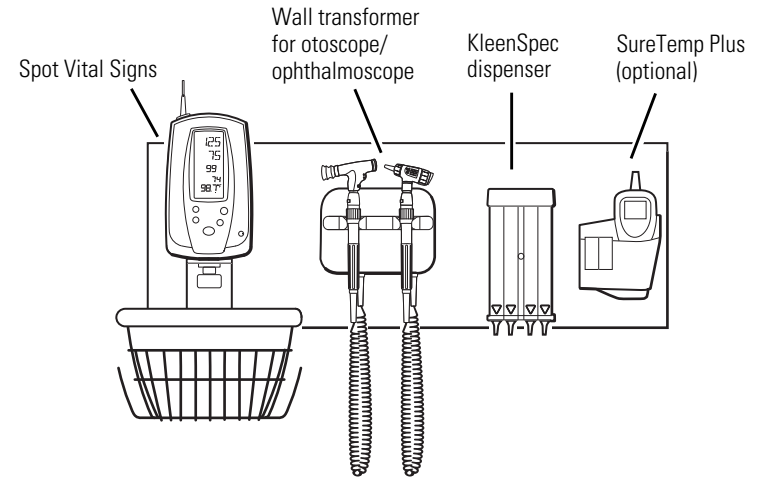

Instrument location—ProBP™

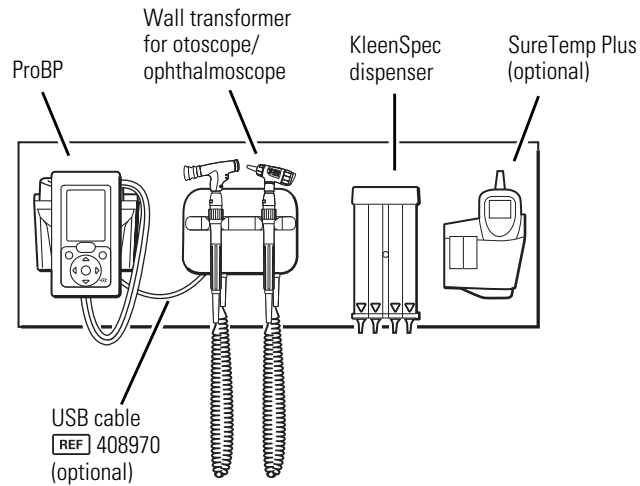

Instrument location—Spot Vital Signs® LXi

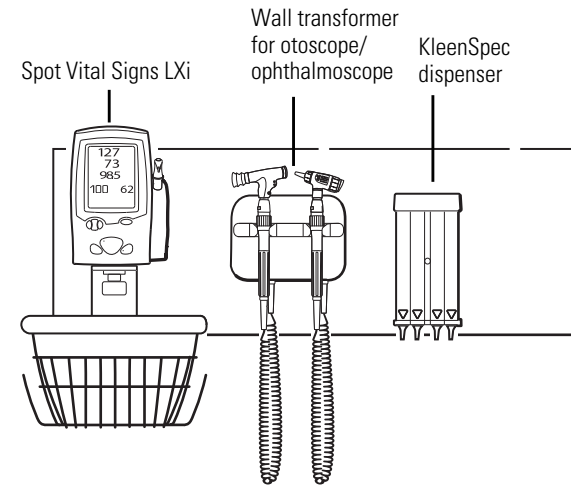

Welch Allyn, Inc.
4341 State Street Road
Skaneateles Falls, NY 13153-0220 USA
www.welchallyn.com



Regulatory Affairs Representative
Welch Allyn Limited
Navan Business Park
Dublin Road
Navan, County Meath
Republic of Ireland